

FAST MOVING TECHNOLOGY

*STÄUBLI*

# Aerospace, transportation and logistics

Connectors | Advanced connection solutions



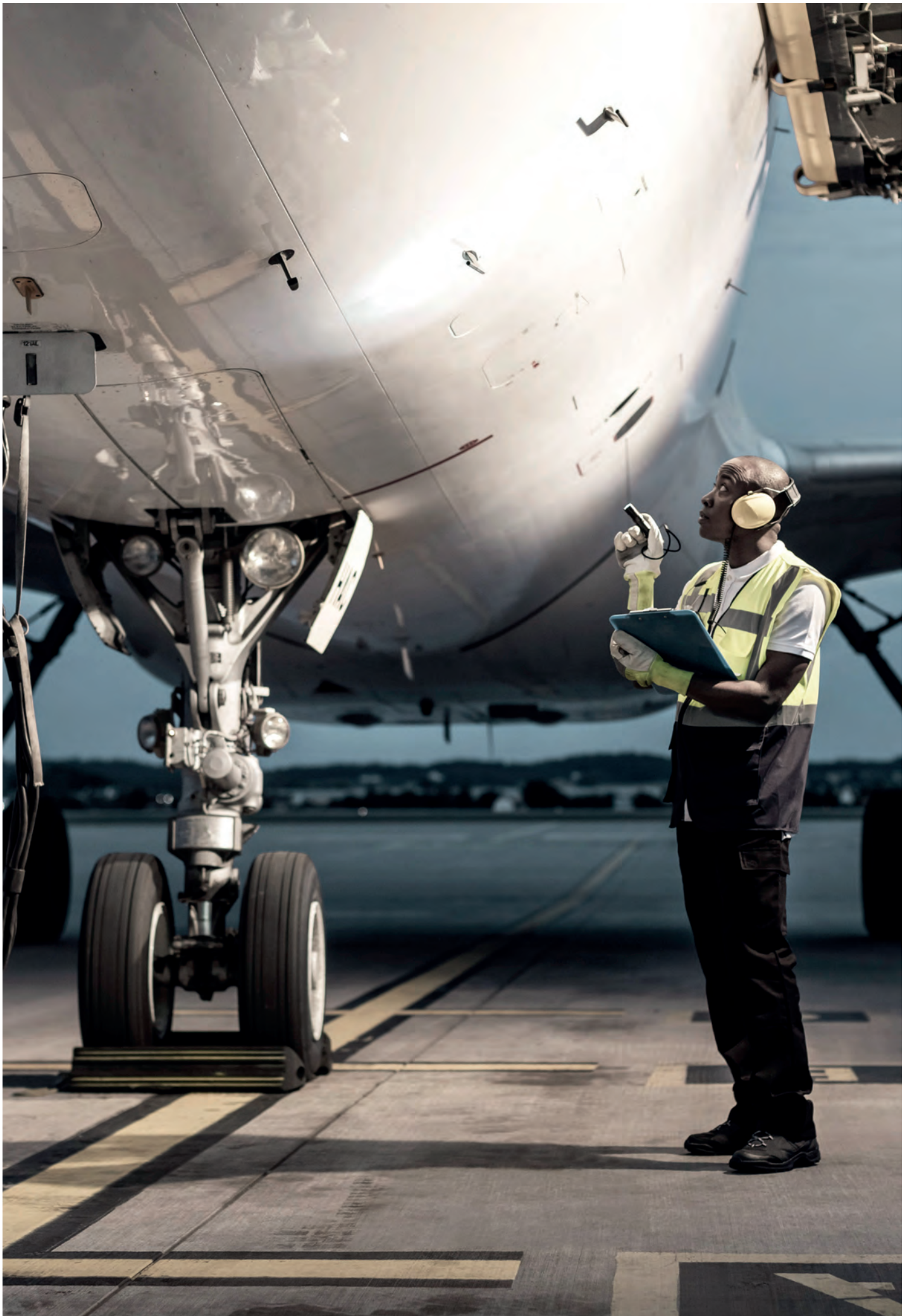

## FAR-SIGHTED PARTNER

# An international Group serving all industrial sectors



**Stäubli, a leading market force, continually pushes for innovation, addressing current and future needs for advanced connection solutions.**

Developing and delivering high-performance solutions tailored to specific business requirements, as well as understanding and anticipating the trends shaping each branch of industry, is the strategy pursued by Stäubli, as global leader in advanced connection solutions for all applications: fluid, gas and electrical.

Fluid mono-connections, electrical connections, multi-connection systems for all energy sources, tool changers for robots or

Quick Mould Change solutions, each Stäubli assembly is engineered and built from parts of consistently matched quality and design. Our solutions improve the reliability, efficiency, performance, and usability of equipment, thereby raising the productivity bar and guaranteeing operator safety.

### **Aerospace, transportation, and logistics: sectors with strict requirements**

The propulsion, power, and control systems of long-haul aircraft carrying hundreds of passengers, subsea technology, or land vehicles in operation do not tolerate the slightest failure.

There are numerous fluid and electrical connections in the civil aviation fields for refuelling, breathing air supply, hydraulic circuits, and cooling electronic equipment such as converters, rectifiers, batteries, etc. Each connection is a vital link, essential for the neat operation and subject to extreme conditions of use, e.g. high differences in temperature, shock, and vibrations.

Stäubli has been working in partnership with the aerospace industry on major international projects for over 40 years. It is recognised for its expertise and ability to supply connection solutions, which perfectly meet the specific requirements of this market.



## OUR FIELD OF EXPERTISE

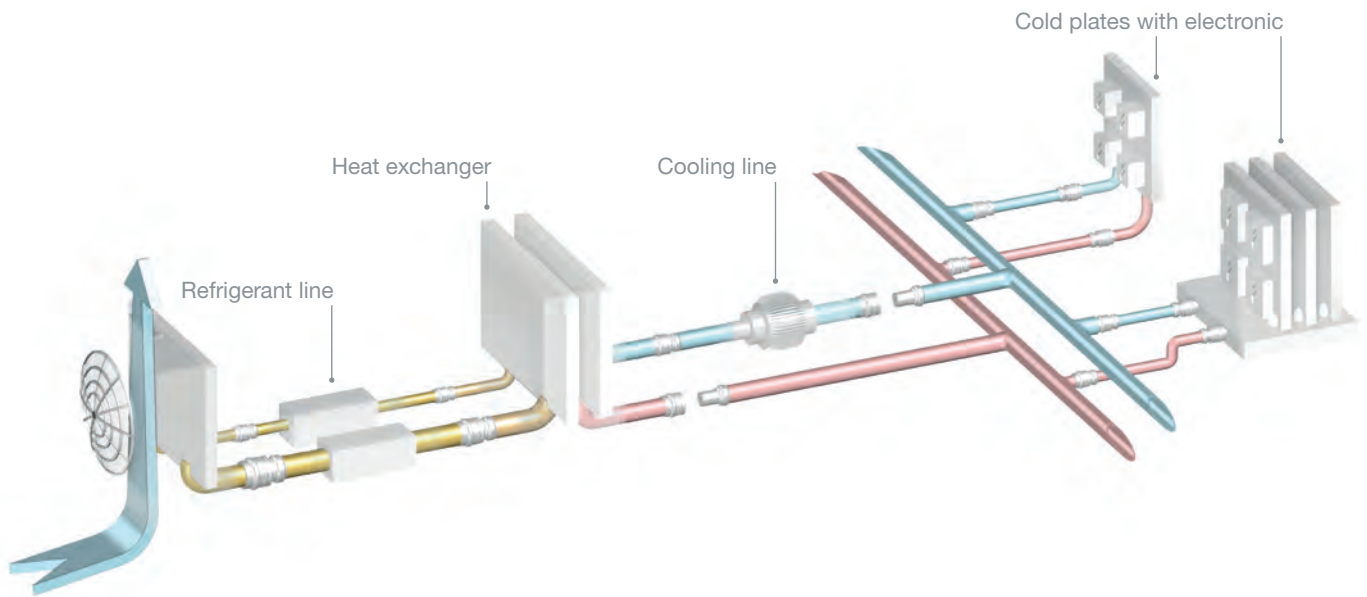

### Air conditioning

#### Split system

Quick-release couplings on air conditioning components (compressor, condenser, evaporator), enable the system to be assembled and disassembled without draining and refilling the circuit with refrigerant. This is the optimal configuration for modular transport devices, like chillers, and air conditioning for tents or shelters.

#### Refrigerant – Fill & drain

In the commissioning phase or for deeper maintenance processes, the line must be completely drained and refilled. Dedicated couplings can be connected to both existing valves.

### Electronic systems – Liquid cooling

Quick disconnections and reconnections of liquid circuits for easy maintenance of electronic systems.

#### Liquid cooling – Main supply

Connections are assured with high flow, flat-face couplings. Pressure relief systems ensure significantly safer connections.

#### Liquid cooling – Cold plate connection

Electronic components are increasingly cooled with liquid-filled cold plates. The maintenance of each component installed on a plate is easily achieved by deploying flat-faced non-spill quick-release couplings.

#### Electrical connections

Power connections are essential for power electronics (backplane to PCB, PCB to PCB, or cable to PCB).

#### Rack connection

Both electrical and liquid cooling connections can be made directly on the rack system.



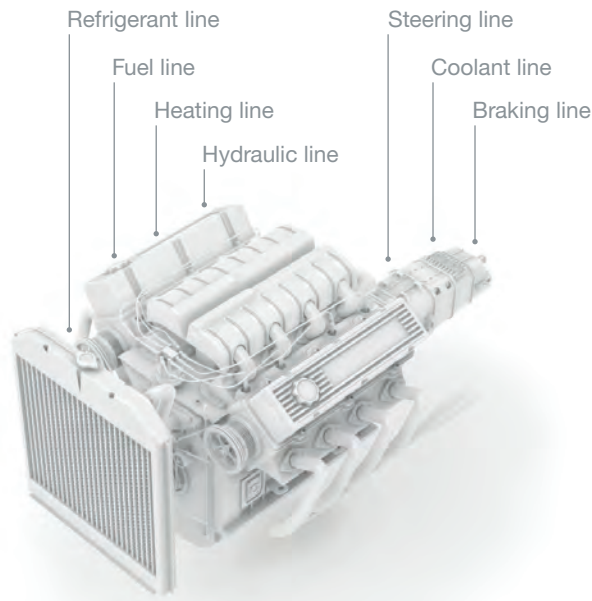
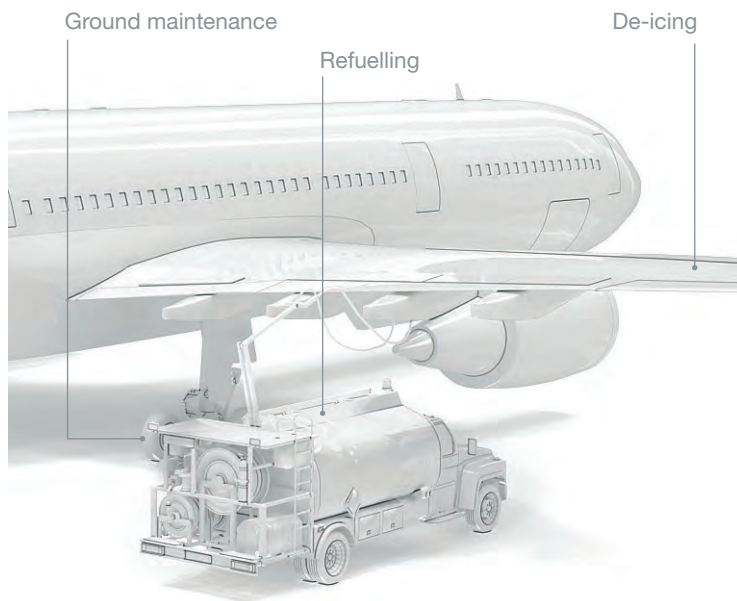

## Fuel & Airport

### Fuel logistics

From the refinery to the final user, fuel transportation requires many connection points. From STANAG to specific dedicated profiles, Stäubli assures safe and non-spill connections.

### Testing

Each line or system must be regularly tested, quick connections are the key for completion of the testing process in the best conditions for safety and quality.

### Airport

In airports, many activities managing fluids need flexibility in the processes. *Modular inter-connectable systems* find optimal efficiency with quick-release couplings.

## Power pack & test benches

### Connections in confined environment

- Fuel lines: from tank to engine and return.
- Coolant and heating lines: connections from the engine to the radiator or from the engine to the heating system can be rapidly secured.
- Hydraulic lines: braking and steering.
- Refrigerant lines: thanks to Stäubli's connections, the lines from the condenser to the evaporator do not require any drainage.

All these connections, applicable on ground vehicles and aircraft engines, participate actively in a quick engine change in confined environments.

### Test benches

Fluid lines equipped with common quick-release connectors can be used for connection to test benches. This avoids misconnection, improves the quality, and reduces the preparation time of the process.

### Alternator output

Thank to their compactness, single-pole and multi-pole power connections can be used in confined spaces.



## OUR FIELD OF EXPERTISE

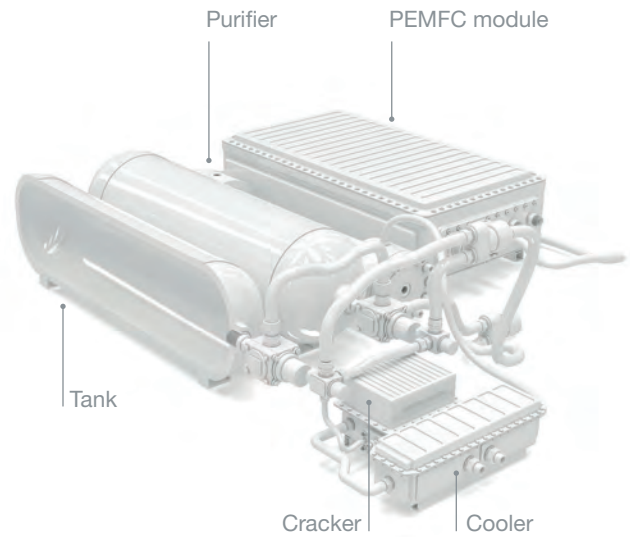
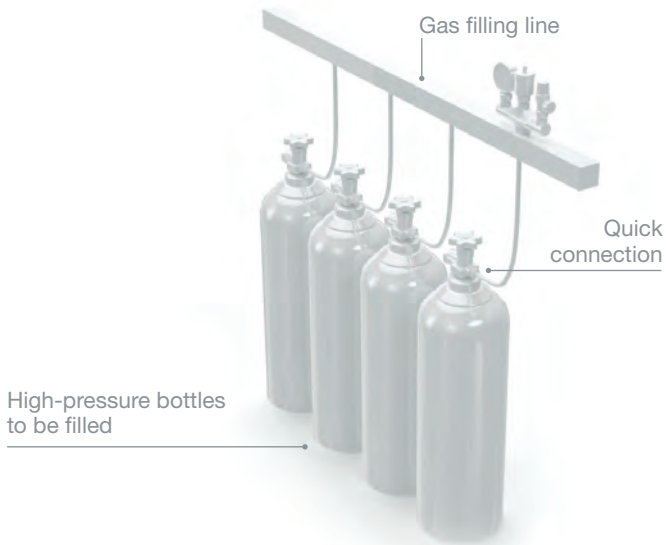

### Medical breathing air

#### Medical

Field hospitals and their logistics during natural disasters need a rapid setup of all installations. Many fluid and electrical connections must be completed for a full commissioning of the modular elements (devices, shelters, tents, etc.).

#### High pressure bottles

Logistics is more than direct connection. The transport of gases in bottles must also be considered. High pressure bottles are required to be connected safely for both filling and when in use. Certain gases such as O<sub>2</sub> or H<sub>2</sub> require specific connectors.

#### Breathing air

Emergency situations or harsh environments require human operation when an autonomous breathing air system must be used. Quick-release connectors ensure fast and flexible deployment during setup.

### Fuel cells & batteries

#### Batteries

The transport sector is energetically transitioning. Unlike the combustion engines, the transportation will use electrical energy, which has to be stored onboard.

Batteries for high-power supplies must be cooled to optimise performance. This is increasingly achieved by the use of liquids. Rapid exchange of liquid cooled batteries is easily executed when quick-release couplings are deployed.

#### Fuel cells

For a longer range and autonomy of the vehicle, batteries are not sufficient. A fuel cell supplied with H<sub>2</sub> connections or an embedded reformer is required. Low or high pressure H<sub>2</sub> connections, in-line or for refilling, are required as well as inerting gases for the system's stop and storage.

#### Electrical connections

As space is critical, Stäubli's low profile power connectors help the OEM to save some precious space in the battery. Battery management systems or even the connection between the different cells/battery packs can be covered with current solutions.



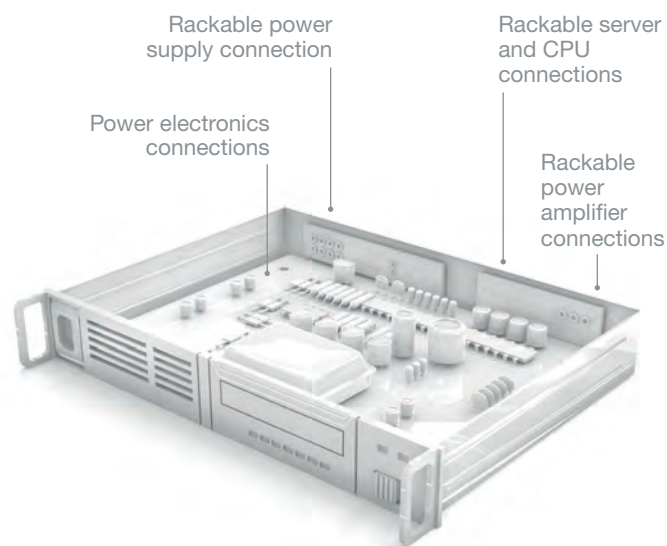
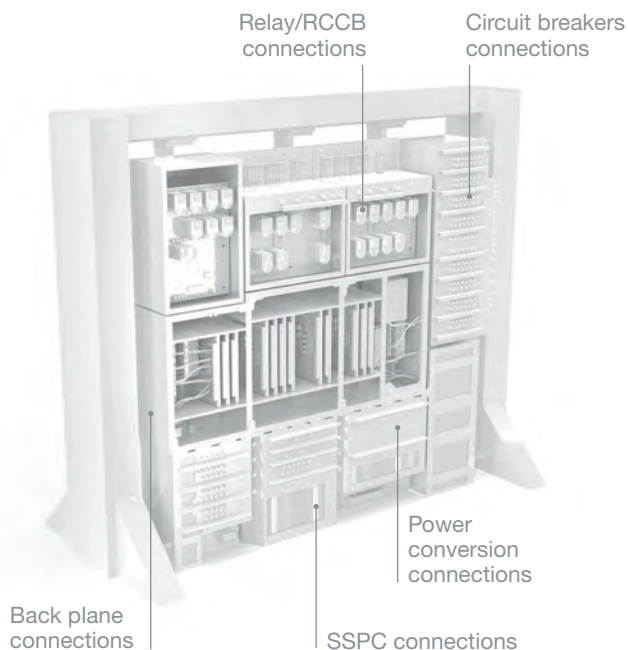

## Power generation, distribution, & conversion

### Switching devices

Either to open/close circuits or to protect loads, actual switching devices are dealing with higher power requirements and the need to be replaceable. Stäubli's power connector solutions allow circuits to be connected directly into the power distribution while being quickly exchangeable with the lowest possible footprint.

### Power conversion

High currents and/or high voltages are a result of increased electrification of the systems. Stäubli's connector solutions address these requirements in the form of handheld or rackable interconnection solutions. They are available with various busbar and cable terminations.

### Power distribution

Stäubli's unique capabilities in the field of power connectors can be used in combination with backplane/busbars, giving unique possibilities to integrate plug-and-play turnkey solutions. This results in e.g. low depth power distribution cabinets.

## Electronic components & systems

### Power electronics

Stäubli's solution allows the OEM to design smaller equipment without compromise on the power side. Direct connection from the backplane to the PCB/PWB or wired connectors to the board with the lowest contact resistance are possible in various geometries.

### Unmanned systems

Stäubli's CombiTac solutions can be used as a charging/docking interface between the system and the charging infrastructure, and provides the highest flexibility through high misalignment absorption capabilities while carrying power and signals.

### Communication & RF systems

The requirements for bigger bandwidth in conjunction with lower TCO (total cost of ownership) push the industry to reduce downtimes. This is addressed with CombiTac, which comes with 10Gbit/s (CAT6A) modules, as well as fiber-optic solutions, with spring-loaded or lens-type contacts. High-frequency solutions are also available.

### Test benches and breakout boxes

Testing the DUT (Device Under Test) before its usage is critical to assure fully functional systems. Stäubli's solutions can be used in ATE (Automated Test Equipment) as well in breakout boxes to simulate the electrical functions.







OUR UNIQUE EXPERTISE AND PARTNERSHIP

# From your objectives to our solutions



**Our Stäubli specialists are constantly increasing their knowledge of the field by listening attentively to their customers and reinforcing close collaboration. The quality of these relationships enables them to analyse each requirement in order to develop the appropriate connection solution that will perfectly meet the expressed needs.**

Whatever solution is proposed, every single one features the advantages the Stäubli range is so well-known for:

**Compactness**

- Maximum flow at minimum size.

**Safety**

- Pressure-tightness using a locking system that prevents accidental disconnection.
- Touch protection and grounding solutions.

**Reliability**

- The ability to withstand multiple connection-disconnection operations, optimum tightness, and resistance to harsh environments all combine to ensure reliable operation in the long term.
- The tried and tested MULTILAM contact technology guarantees a perfect connection, thanks to its natural flexibility and its outstanding technical characteristics. Vibration resistance and low contact resistance ensure reliable operation of long-term use.

**Clean-break**

- Our quick-release couplings ensure clean connection and disconnection, preventing contamination of the circuit and of the environment.

## OUR UNIQUE EXPERTISE AND PARTNERSHIP

# Working with you from day one of your project

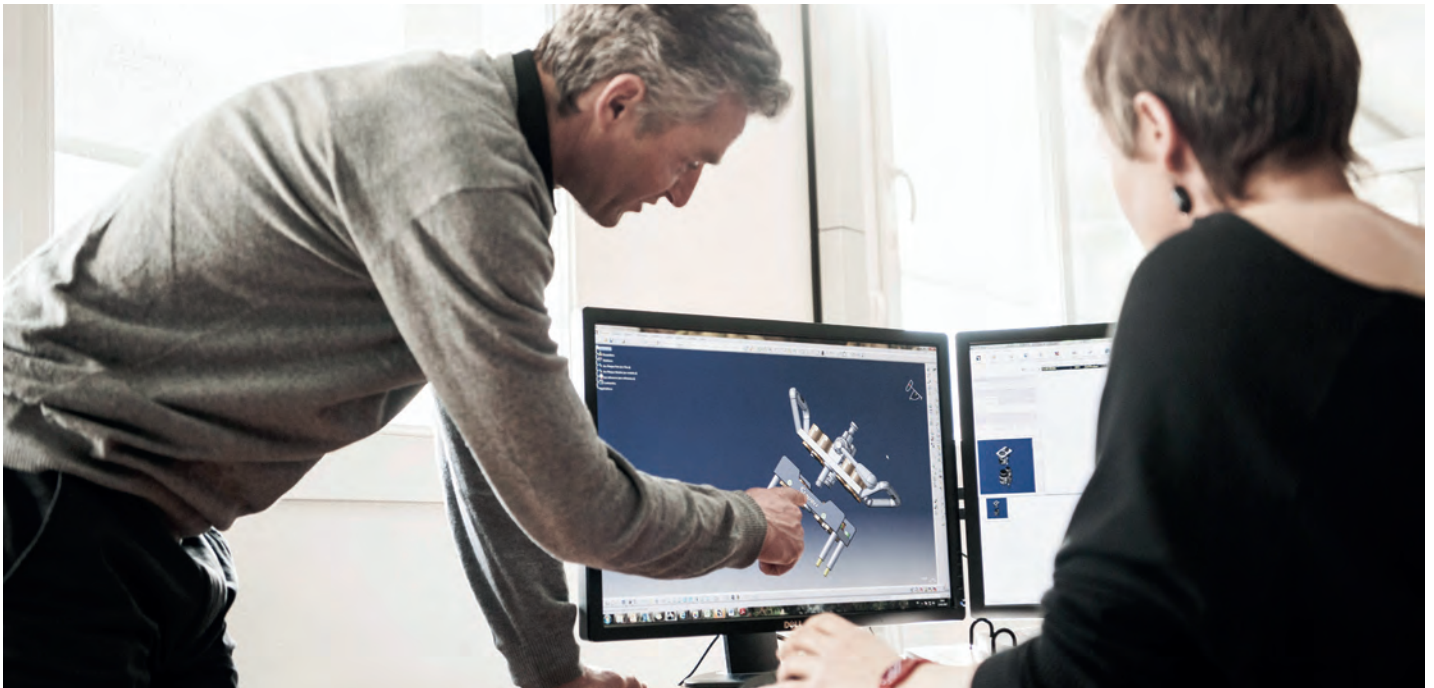

**The experts in our Research & Development teams offer thorough support in designing solutions that will meet the requirements of your application in every respect and be compatible with your existing equipment.**

**Stäubli's CAD tools, rapid prototyping, and dedicated testing equipment ensure the suitability of the components as defined by your specifications.**

### **Quality above all else**

Stäubli's production, metrology, and metallurgy departments utilise the latest technology to assure the best quality of the products provided to ensure full traceability. Our methods are certified by the most stringent standards:

- ISO 9001
- RTCA DO 160
- MIL-STD-810 compliance upon request

### **Effective testing and measurement**

Stäubli uses high-tech tools to inspect your products:

- 3-axis optical measuring machine
- X-ray fluorescence
- Spectrometer
- Testing equipment: helium, gas (up to 3,500 bar), oil (up to 4,000 bar), water (from 0 to 10,000 bar), hydraulic and pneumatic drop tests, pressure drop, thermal shock, vibration (up to 3,000 Hz and accelerations up to 112 g), mechanical endurance and corrosion resistance tests (saline spray enclosure), and climatic tests.



# Limitless expertise



**Stäubli develops quick connection solutions that are ideal for extreme operating conditions at sea, on land and in the air. With broad and profound expertise in the most specific applications, Stäubli offers an unlimited response to its customer's requirements.**

## Medical

In emergency situations, it must be possible to set up advanced medical stations as close as possible to risk areas. With its wide-ranging expertise, Stäubli is able to equip field hospitals and provide connections for filling oxygen cylinders.

## Busbar solutions

Stäubli Electrical Connectors as a solution provider is able to offer connectors and busbar as a turnkey solution, while staying considerate specific quality and environmental requirements.

## Space

Scientific experiments are carried out in zero gravity under extreme conditions. Stäubli has transferred its land-based know-how to develop a unique solution used on the ISS.

## Filling

With their high resistance to hydrocarbons, pressure and vibration, Stäubli's quick release couplings and refuelling systems ensure safe and rapid filling of various types of equipment (aircraft, UAVs, UWMs, helicopters, etc.).

## Dynamic applications

The MULTILAM contact technology enables high efficiency rotating joint solutions with low contact resistance and no compromise on dimensions or technology. Stäubli solutions are used on various sea and land-based systems.

## Civil aviation

Stäubli is directly involved in various R&D programs developing the "more electric aircraft" by providing its expertise in modular electrical connector technology. Stäubli's solutions combine power, signals, data, and mechanical float mounts, ideal for aerospace applications.



■ Stäubli Units    ○ Representatives/Agents

## Global presence of the Stäubli Group

[www.staubli.com](http://www.staubli.com)

Stäubli is a trademark of Stäubli International AG, registered in Switzerland and other countries. © Stäubli 2020.  
We reserve the right to modify product specifications without prior notice.  
[connectors.mkg@staubli.com](mailto:connectors.mkg@staubli.com)

Photo credits:

Getty Images: guvendemir - Serega - Douglas Sacha - Monty Rakusen - Caiimage-Agnieszka Olek - Stocktrek Images  
• Stäubli • Illustrations 3D: Pump

**STÄUBLI**